



•Fall Protection •Training •Netting •PPE

CLASS 2 SELF RETRACTABLE LIFELINE INSTRUCTION MANUAL



These Instructions Apply to the Following Model(s):

SRL121122, SRL121122T, SRL121132, SRL121132T, SRL121142, SRL121142T,
SRL411212, SRL411222, SRL911212, SRL711212, SRL1111212

Do not skip this instruction manual. Read the instruction manual carefully before using the equipment. If failed in doing so it may cause Serious injury or Death.

This manual must be read and understood in its entirety and used as part of fall protection training program as required by OSHA or any state regularity agency. These instructions are intended to meet the manufacturer instructions as required by ANSI Z359.14 and OSHA 1926. The user must fully understand the proper equipment use and limitations.

TABLE - SPECIFICATION (ANSI SRL)						
Model Number	Lifeline Material and Size	Lifeline Length	Maximum Arresting Force	Average Arresting Force	Maximum Arrest Distance	Comply ANSI/ASSP Z359.14-2021 Class
SRL121122	Dyneema Webbing (Black) 3/4" width	6 ft.	1800 lbs.	1350 lbs.	42 inches	2
SRL121122T	Dyneema Webbing (Black) 3/4" width	6 ft.	1800 lbs.	1350 lbs.	42 inches	2
SRL121132	Dyneema Webbing (Black) 3/4" width	6 ft.	1800 lbs.	1350 lbs.	42 inches	2
SRL121132T	Dyneema Webbing (Black) 3/4" width	6 ft.	1800 lbs.	1350 lbs.	42 inches	2
SRL121142	Dyneema Webbing (Black) 3/4" width	6 ft.	1800 lbs.	1350 lbs.	42 inches	2
SRL121142T	Dyneema Webbing (Black) 3/4" width	6 ft.	1800 lbs.	1350 lbs.	42 inches	2
SRL411212	7/32" Galvanized Steel Cable	12 ft.	1800 lbs.	1350 lbs.	42 inches	2
SRL411222	7/32" Galvanized Steel Cable	12 ft.	1800 lbs.	1350 lbs.	42 inches	2
SRL911212	7/32" Galvanized Steel Cable	18 ft.	1800 lbs.	1350 lbs.	42 inches	2
SRL711212	7/32" Galvanized Steel Cable	30 ft.	1800 lbs.	1350 lbs.	42 inches	2
SRL111212	7/32" Galvanized Steel Cable	50 ft.	1800 lbs.	1350 lbs.	42 inches	2

GENERAL REQUIREMENTS, WARNINGS AND LIMITATIONS:

- The Equipment is designed for use as a part of a personal fall protection system. Components must not be used for any other operation other than that which it has been designed and approved. Fall Arrest system are designed to comply with OSHA. Fall Restraint System must be designed by a Qualified Person, and must be installed and used under the supervision of a competent person.
- All authorized persons/users must refer to the regulations governing occupational safety. Please refer to product labeling for information on specific OSHA regulations, and ANSI standards met by product.
- Consult a doctor if there is any reason to doubt a user's ability to withstand and safely absorb fall arrest forces. Age, fitness, health conditions can seriously affect the worker when a fall occurs. Pregnant Women and minors should not use this equipment.
- Proper precautions should always be taken to remove any obstructions, debris, material, or other recognized hazards from the work area that could cause injuries or interfere with the operation of the system. All equipment must be inspected before each use according to the manufacturer's instructions. All equipment should be inspected by a qualified person on a regular basis.
- To minimize the potential for accidental disengagement, a competent person must ensure system compatibility.
- Equipment must not be altered in any way. Repairs must be performed only by the Manufacturer, or persons or entities authorized in writing by the manufacturer.
- Any product exhibiting deformities, unusual wear, or deterioration must be immediately discarded.
- Any equipment subject to a fall must be removed from service. The authorized person/user shall have a rescue plan and the means at hand to implement it when using this equipment.
- Never use fall protection equipment for purposes other than those for which it was designed. Fall protection equipment should never be used for towing or hoisting.
- All synthetic material must be protected from slag, hot sparks, open flames, or other heat sources. The use of heat

resistant materials is recommended in these applications.

- Never use natural materials (manila, cotton, etc.) as part of a fall protection system.
- Do not expose this equipment to chemicals which may have a harmful effect on the materials used to construct it. Be especially aware of caustic environment, or those that contain high levels of organic acids or bases. If you are uncertain about the safe operation of this equipment in any environment, contact Palmer Safety for further instructions.
- Do not use the equipment near sharp edges and abrasive surfaces.
- Do not use the equipment around moving machinery or electrical hazards.
- Palmer Safety Self Retractable Lanyards should be used only with the combinations of components, sub-systems or both which may affect or interfere with the safe function of one another. Be certain that connecting devices are compatible and that other elements of the PFAS are safe to use and compatible before use.

TRAINING REQUIREMENTS: The employer must provide a training program for each employee who might become exposed to fall hazards. The program must enable each employee to recognize the hazards of falling and must train each employee in the procedures to be followed in order to minimize these hazards. Relevant Federal, State, and local requirements, procedures, and standards must also be a part of training.

The employer must ensure that each employee has been trained, as necessary, by a Competent or Qualified Person in the nature of fall hazards in the work area, the correct erecting, maintaining, disassembling, and inspection of the fall protection systems being used, and the use of personal fall arrest systems.

RESCUE PLAN: The user is required to have a rescue plan and the means at hand to implement the plan when using the equipment. The plan must be the event of a fall.

HORIZONTAL LIFELINE (HLL) AND RAIL SYSTEMS: The SRD may be attached to rigid and flexible anchors provided that all HLL or rail system applications, installation, and uses are under the supervision of a Qualified Person.

APPLICATION LIMITS: The SRD discussed in this manual is designed for Leading Edge applications. However, take caution to avoid very sharp edges such as sheared metals, metals cut with an abrasive disk, or flame-cut metals. Also take caution around very abrasive surfaces and edges, such as concrete or stone, as these edges and surfaces may abrade the lifeline or the energy absorber during a fall event.

EQUIPMENT IS SUBJECTED TO A FALL: Remove the equipment from service immediately if it has been subjected to the force of a fall arrest. Contact your distributor or Palmer Safety about policies regarding replacement of Palmer Safety components involved in a fall incident.

INSPECTION:

- Only the manufacturer of this equipment or persons or entities authorized in writing by the manufacturer shall make repairs to fall protection equipment.
- The date of first inspection should be recorded by the employer on the equipment, and any serial number must be recorded on the owner's Inspection Log.
- Formal inspections must be made by either a Competent or Qualified Person on (at least) a semi-annual basis.

PRIOR TO EACH USE:

- Fall protection equipment must be inspected by the user for defects, damage, or deterioration.
- Any suspected defective equipment must be removed from service immediately.
- If the manufacturer's label is not legible or is missing, the equipment must be removed from service.
- Fall protection equipment must be removed from service upon evidence of defects, damage, or deterioration, or upon expiration of the manufacturer's specified service limits, whichever comes first.

MAINTENANCE, CLEANING, AND STORAGE: Repairs to equipment must be administered only by a Palmer Safety representative or person or entity authorized by Palmer Safety. Contact Palmer Safety to request equipment maintenance and/or repair. Cleaning after use is important for maintaining the safety and life of the equipment. Clean the equipment of all dirt, corrosives, and contaminants. If the equipment cannot simply be wiped clean use a mild soap and water. Rinse, wipe, and hang to dry. Store equipment where it cannot be affected by heat, light, excessive moisture, oil, chemicals, or other degrading elements.

⚠️ WARNING

Consult with your medical doctor if there is reason to doubt your fitness to safely absorb the shock from a fall arrest, Age, fitness, and health conditions can seriously affect a worker’s ability to withstand falls. Pregnant women and minors must not use any Palmer Safety Fall Protection equipment.

DESCRIPTION OF PRODUCT:

Retractable: All Palmer Safety Retractable are hereby referred to as Self Retracting Lifeline (SRL). The device is used to safely expand the working area where a harness with a 6 ft. lanyard is not adequate. Also, a SRL is designed to reduce the shock loading to the body of a worker by limiting the distance of a fall. The device allows for complete freedom of movement. The SRL is to be considered part of a personal fall arrest system (PFAS). The SRL is to be used as part of a complete fall arrest system. PFAS normally include the use of a full body harness, anchorage connector such as a carabiner and the SRL.

Product Components

- A. Swivel Top
- B. Housing
- C. UHMWPE Webbing or Galvanized Steel Cable
- D. Shock Pack
- E. Corresponding Model Hook (e.g. snap hook, rebar hook, etc.)

Palmer Safety Class 2 Self Retracting Lifeline: Includes a swivel eye anchorage, self-locking swivel snap hook with impact indicator or rebar hook, and 3/4” UHMWPE Webbing or 7/32” Galvanized Steel Cable. SRL also comes with a carabiner and tag line to be used with the device to avoid improper use.

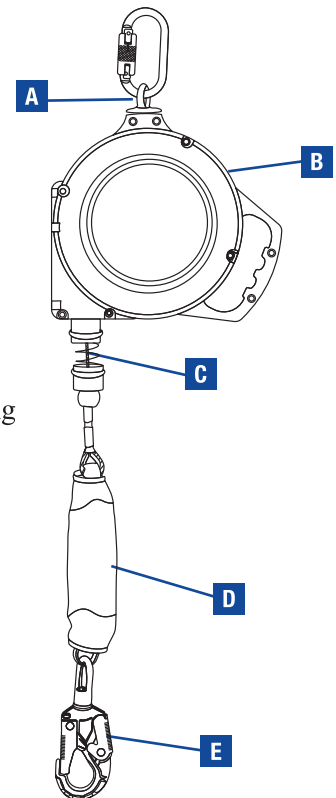

PRODUCT APPLICATION INFORMATION: The SRL is used in a stationary or mobile manner. As a stationary device, the SRL would be mounted to an approved fixed anchorage connector directly overhead. The SRL would extend as the user moves away from the anchor point and it retracts as the user moves back towards the anchorage point. As the SRL is used in a mobile manner, the device should be traveling on a steel cable, rope or fixed rail traveling from one anchorage connector to the other.

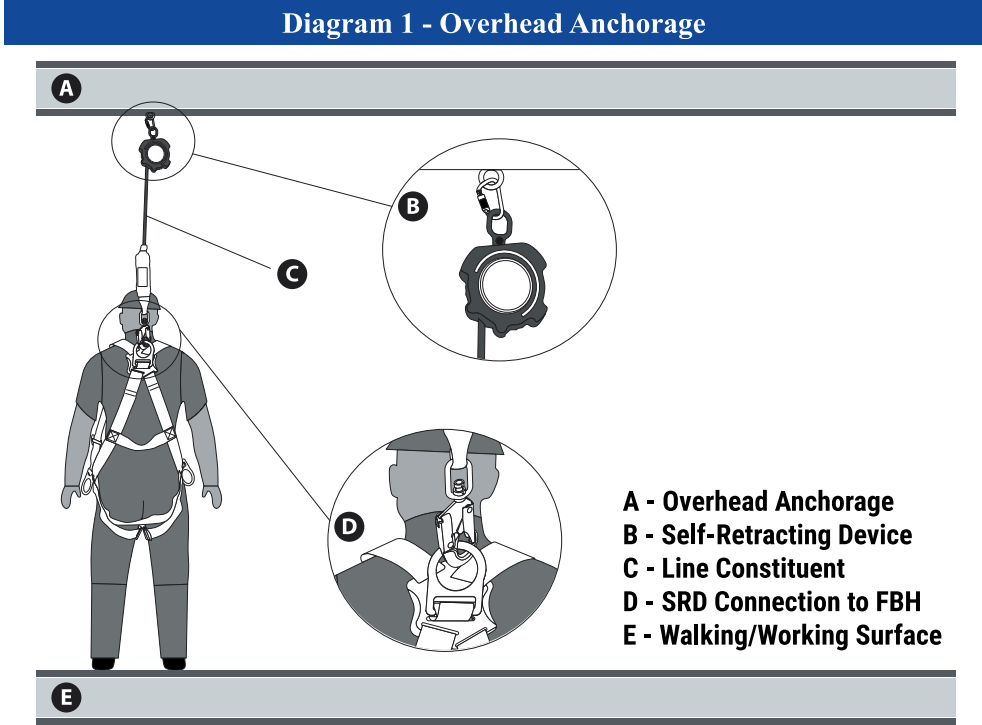

APPLICABLE STANDARDS:

Refer to potential applicable standards. Standards might include OSHA regulations depending on the type of work, and also might include state regulations where applicable. Consult regulatory agencies for more information on personal fall arrest system and associated components. This product is designed to comply with OSHA and ANSI Z359.14 standards when used properly, and in accordance with manufacturer’s instructions.

LIMITATIONS:

Consider the following application limitations before using this equipment.

- **Capacity:** The SRL is for use by one person with a combined weight (person, clothing, tools, etc.) of 130 lbs. minimum and 310 lbs. maximum up to 420 lbs. No more than one person may be connected at one time.
- **Corrosion:** Leaving the SRL in an environment for long periods of time that could cause corrosion of metal parts is not warranted in any way and must not be done. Use caution when working around corrosive compounds such as ammonia, sewage, fertilizers, seawater or other corrosive environments, may require more frequent inspections or servicing. These increased inspections and servicing are required to ensure corrosive damage is not impacting the performance of the SRL.
- **Chemical Hazards and Heat:** Extreme caution must be taken when working in or around environments containing acid or caustic chemicals, particularly at elevated temperatures. Damage will result to SRL's in this environment. Chemical damage is difficult to detect and it is recommended that the lifeline be replaced periodically to ensure safety of the workers. Additionally, this SRL is not to be used in high temperature environments. The SRL must be protected when using near welding, metal cutting, or similar activities. Hot sparks and slag can damage this equipment. Users must inspect SRL prior to each use.
- **Electrical Hazards:** For web and wire rope models, there is a possibility of an electric current flowing through the lifeline. Moisture absorbed by the lifeline may provide a path for electrical current to flow, resulting in electrical shock. Use caution where the lifeline may contact high voltage power line.
- **Locking Speed:** Extreme caution should be taken when using this device whereas an obstructed fall could occur as well as when someone must perform work in a confined or cramped space. Working in these types of environments could limit the speed at which the locking mechanisms engage. Extreme caution should be taken when working on low pitched roofs, where a worker may slide instead of fall. A clear path is required to ensure positive locking of the SRL.

CONSIDER WHEN CALCULATING DISTANCE:

- Distance of Deceleration
- Movement of harness attachment element (D-ring)
- Free Fall Distance
- Worker Height (Worker's height could affect the free fall distance)
- Elevation of Anchorage Connector
- Lengths of Connecting Subsystems

Diagram 2 - Required Fall Clearance Calculation w/Overhead Anchorage

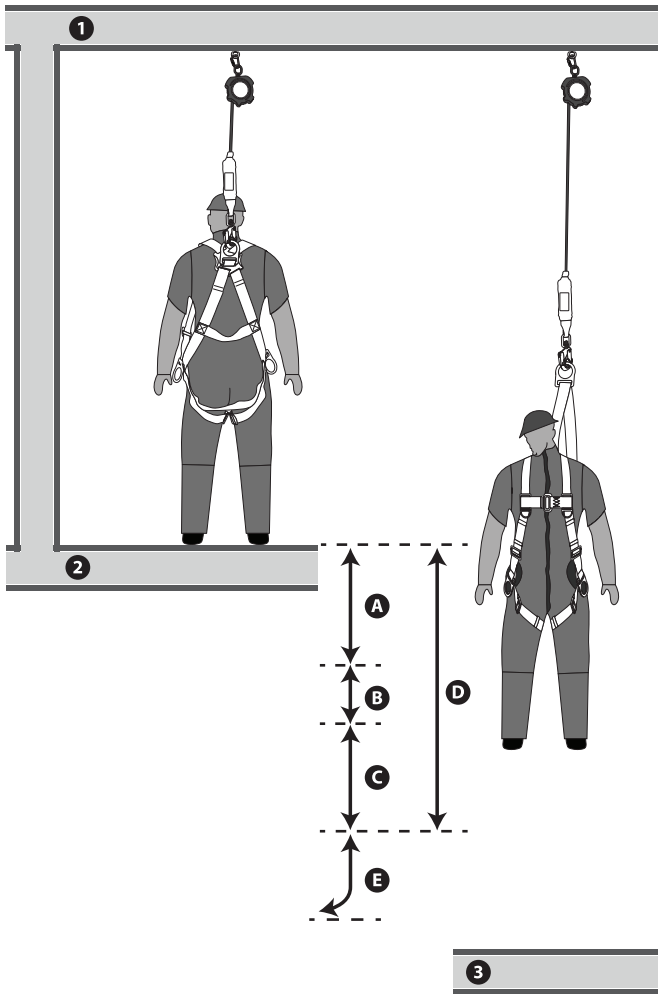

Diagram Point	Distance	Factors
A	2 ft.	Deceleration Distance Maximum allowable length of cable or web that may payout from the SRD once deceleration of the user has begun and after a fall event occurs.
B	1 ft.	D-ring Shift and Harness Stretch Combined amount of Dorsal D-ring up-shift and harness webbing elongation during entire fall event
C	2 ft.	Safety Factor Added length to account for other factors such as an improperly adjusted harness, actual worker height or worker weight
D	5 ft.	Minimum Fall Clearance Required (Subtotal) for direct overhead use of SRD (not accounting for Swing Fall); sum of A, B and C only
E	***	Swing Fall Additional Fall Clearance Calculation needed. Use Chart 1 below.
D + E =		
Required Fall Distance		
1	Working Level	
2	Walking/Working Surface	
3	Nearest Lower Level or Obstruction	

Chart 1 - Swing Fall Additional Fall Clearance w/Overhead Anchorage

Use this Chart to Find Additional Fall Clearance with Overhead Anchorage

The X-Axis represent the distance the user is working away from being directly under the SRD in 2 foot increments.

The Y-Axis represent the SRD Anchorage height above the user's Dorsal D-Ring in 5 foot increments.

To find the additional Fall Clearance needed to compensate for potential Swing Fall, note the starting location on chart titled "Dorsal D-Ring".

Work Zone Use Areas

- Allowable
- Cautionary
- Not Allowed

		Swing Fall Additional Fall Clearance with Overhead Anchorage (Feet)																			
Y-Axis: SRD Anchorage Height Above Dorsal D-Ring of FBH	50	0	0	0	0	1	1	1	2	2	3	4	5	5	6	7	8	9	10	12	
	45	0	0	0	0	1	1	2	2	3	3	4	5	6	7	8	9	10	11	13	
	40	0	0	0	0	1	1	2	2	3	4	5	6	7	8	9	10	11	12	14	
	35	0	0	0	1	1	1	2	3	3	4	5	6	7	9	10	11	12	14	15	
	30	0	0	0	1	1	2	2	3	4	5	6	7	8	10	11	12	14	15	17	
	25	0	0	0	1	1	2	3	4	5	6	7	8	10	11	13	14	16	17	19	
	20	0	0	0	1	2	2	3	4	6	7	8	10	11	13	14	16	18	19	21	
	15	0	0	1	1	2	3	4	6	7	8	10	12	13	15	17	19	20	22	24	
	10	0	0	1	2	3	4	6	7	9	11	12	14	16	18	20	22	24	25	27	
	5	0	0	1	3	4	6	8	10	12	14	16	18	20	21	23	25	27	29	31	
	0	Dorsal D-Ring	2	4	6	8	10	12	14	16	18	20	22	24	26	28	30	32	34	36	
Ft.	0	2	4	6	8	10	12	14	16	18	20	22	24	26	28	30	32	34	36		
		X-Axis: Lateral Work Zone Radius (ft.) →																			

LIMITATIONS CONTINUED:

- **Swing Falls:** Swing falls occur when the anchorage point is not directly above the point where a fall occurs. The force of striking an object in a swing fall may cause serious injury or death. Minimize the risk of a swing fall by working as close to the anchorage point as possible. Do not permit a swing fall if injury could occur. Swing fall will significantly increase the clearance required when a self retracting lifeline or other variable length connecting system is used.
- **Potential Environmental Hazards:** Use of fall protection equipment in areas with environmental hazards may require additional precautions to prevent injury to the user or damage to the equipment. Hazards may include but are not limited to: chemicals, corrosive environments, high voltage power lines, gases, moving machinery, and sharp edges.

SYSTEM REQUIREMENTS:

- **Compatibility of Components:** Palmer Safety Fall Protection equipment is designed to be used with Palmer Safety approved components. Please contact Palmer Safety if you have a question regarding compatibility. Making substitutions without approval from Palmer Safety Protection may lead to injuries and or death by compromising the safety and reliability of any component or that of the complete system. A qualified and competent person can make a determination on compatibility of equipment from different manufacturers. If in doubt, please contact Palmer Safety Fall Protection for clarification.
- **Compatibility of Connectors:** Connectors (D-rings, hooks, carabiners) must be capable of supporting at least 5,000 lbs. (22kN). Do not use equipment that is not compatible. Non-compatible connectors may unintentionally disengage. Self locking snap hooks and carabiners are required by ANSI and OSHA. Connectors must be compatible in size, shape, and strength.
- **Making Connections:** Only use self-locking snap hooks and carabiners with any Palmer Safety Fall Protection equipment. Do not use equipment that is not compatible. If you have any questions on compatibility, please contact Palmer Safety Fall Protection.

Diagram 3 - Swing Fall Hazards w/Overhead Anchorage

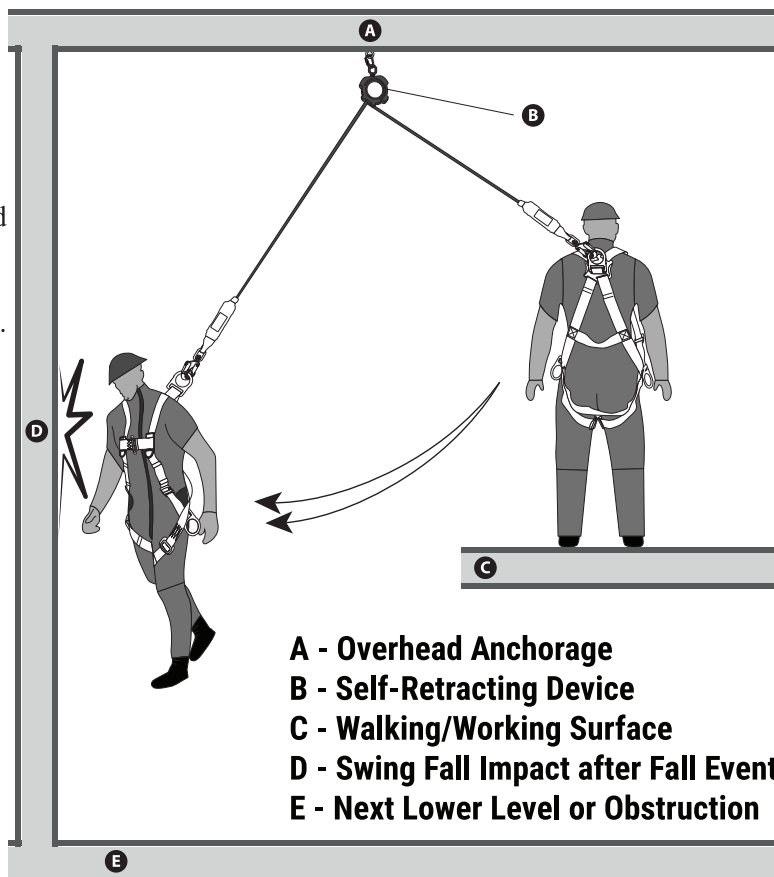

⚠ WARNING

Large throat opening snap hooks should not be connected to standard size D-rings or similar objects which will result in a load on the gate if the hook or D-ring twists or rotates. Large throat snap hooks are designed for use on fixed structural elements such as rebar or cross members that are not shaped in a way that can capture the gate of the hook.

More on Compatibility: To avoid interference when connecting, there must be enough space between the hook and its attachment point. This is known as “rolling out” and can cause the gate on the hook to inadvertently open and release. All connectors should be self-closing and self-locking, and should withstand a minimum load of 5,000 lbs.

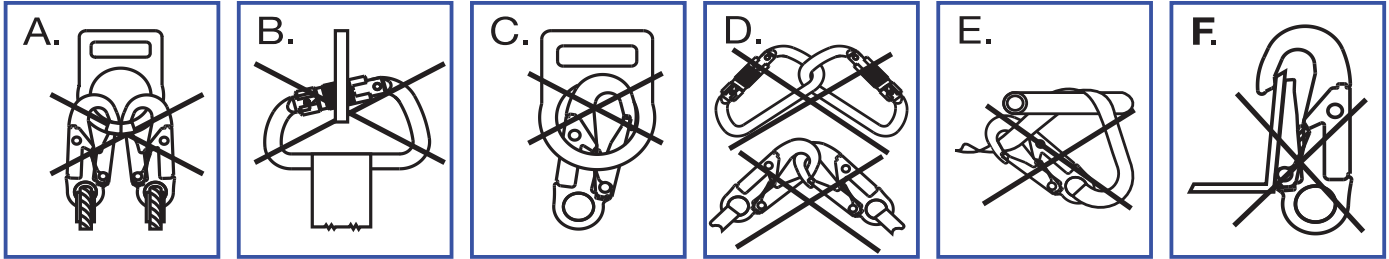

- A. Two or more connectors should never be attached to a single D-ring.
- B. Never attach a connector that could result in a load on its gate.
- C. Connectors should not be connected in a false engagement. It should be visually confirmed that the connector is fully engaged to the anchor point. Avoid conditions that allow for features that protrude from the connectors to catch on the anchor, giving a false sense of being connected.
- D. Connectors should not be connected to each other.
- E. Connectors should not be connected directly to the webbing or to the rope lanyard or tie back, unless specifically allowed by the manufacturer.

F. Connectors should not be connected to any object which does not allow the connector gate to close or lock. Anchor shapes that allow roll out to occur should never be used for connection. If the anchor, to which the snap hook or carabiner is attached, is under sized or irregular in shape, then this may allow for the gate of the connector to come in contact with the anchor, thereby causing the connector to open up and possibly disengage from the anchor. This is known as roll out of the connector. See Diagram 4.

Diagram 4 - Unintentional Disengagement (roll-put)

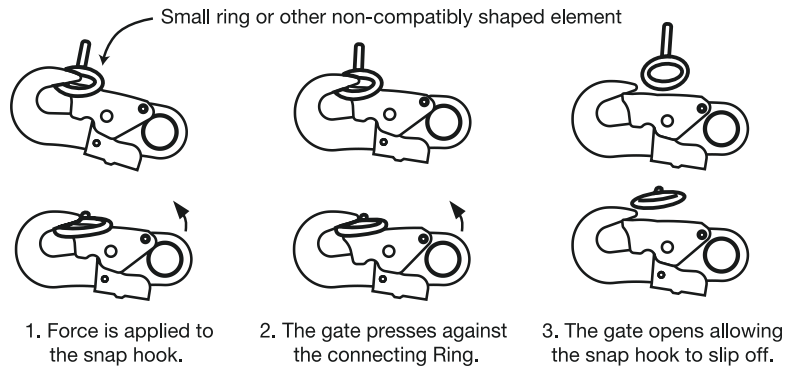

G. Do not use connectors on an anchorage object as shown in figure A to F.

PERSONAL FALL ARREST INFORMATION:

Personal Fall Arrest System (PFAS): Personal fall arrest systems used with this equipment must meet applicable state, federal, OSHA, and ANSI requirements. A full body harness must be worn when this equipment is used as a component of a personal fall arrest system. As required by OSHA, the personal fall arrest system must be capable of arresting the user's fall with a maximum arresting force of 1,800 lbs., and limit the free fall to six feet or less.

WARNING

Do not alter or intentionally misuse this equipment. Consult with Palmer Safety when using this equipment in combination with components or subsystems other than those described here in this manual and or other information. Use caution when using this equipment around moving machinery, electrical and chemical hazards, and sharp edges.

A Personal Fall Arrest System is an assembly of components and subsystems used to arrest a person during a fall event. A Personal Fall Arrest System typically consists of an anchorage, a deceleration device such as a Shock Absorbing Lanyard, a Self-Retracting Device, or an approved fall protection anchor, and a properly fitted Full Body Harness. Maximum permissible free fall in a typical PFAS is 6'. Class 2 SRD's discussed in this manual may be used in non-overhead anchorage situations. Clearance calculators provided in this manual offer methods for calculating Minimum Required Fall Clearance (MRFC) for non-overhead anchorage locations when the SRD is set back from 0' to 4' and non-overhead anchorage locations that are set back 5' or greater. See Diagram 5.

Diagram 5 - Class 2 SRD Anchorage Locations

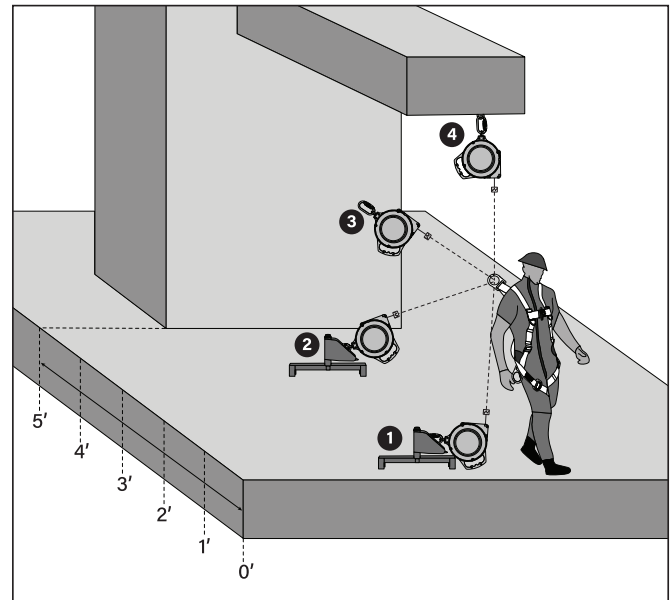

Diagram Point	Anchorage of a Class 2 SRD
1	At Foot Level with 0' Setback from Leading Edge
2	At Foot Level with 5' Setback from Leading Edge
3	Above Dorsal D-ring with 5 ft. Setback from Leading Edge
4	Overhead Above Dorsal D-ring

CALCULATING FALL CLEARANCES:

Applications for Overhead, Non-Leading Edge Anchorage:

Palmer Safety Class 2 SRD's can be used in an overhead condition in the same configuration as a Class 1 SRD in areas above the D-ring. The overhead condition Minimum Required Fall Clearance (MRFC) is calculated using four metrics, measured from the walking-working surface:

1. SRD Deceleration Distance
2. D-Ring Shift and Harness Stretch (1 ft.)
3. Safety Factor (2 ft.)
4. Swing Fall

Chart 2 below is calculated using the performance data of the SRD and includes all four metrics listed previously to determine the MRFC.

Diagram 6 - Overhead Anchorage MRFC

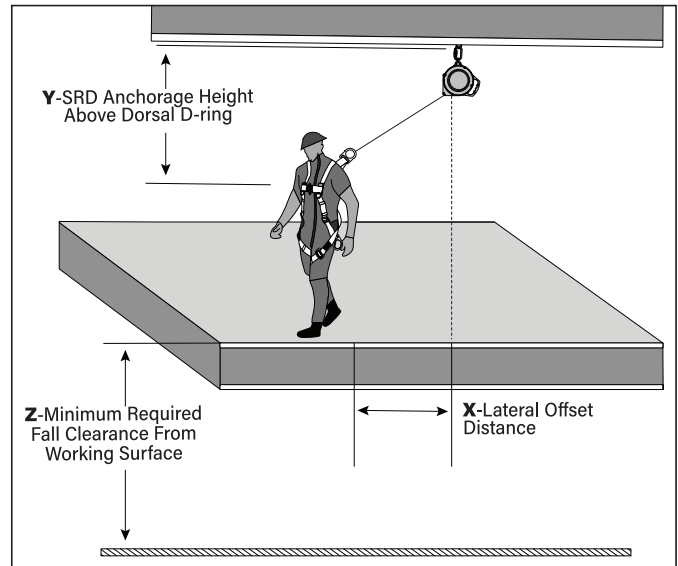

Chart 2 - Calculating Minimum Required Fall Clearance w/Overhead Anchorage

Use this Chart to Calculate Minimum Required Fall Clearance for Overhead Anchorage

The X-Axis represents the Lateral Offset Distance the user is working away from being directly under the SRD in 2 foot increments.

The Y-Axis represents the SRD Anchorage height above the user's Dorsal D-Ring in 5 foot increments.

Example: If the SRD is anchored 20 feet above the user's Dorsal D-Ring, the user needs to work within 12 feet away.

Work Zone Use Areas

- Allowable
- Not Allowed - WORKING IN THIS AREA MAY RESULT IN SERIOUS INJURY OR DEATH

		(Z): Minimum Required Fall Clearance w/Overhead Anchorage (Feet)												
(Y): SRD Anchorage Height Above Dorsal D-Ring of FBH (ft.)	Ft.	0	2	4	6	8	10	12	14	16	18	20	22	24
	60	6.5	7	7	7	7.5	7.5	8	8.5	9	9.5	10	10.5	11.5
55	6.5	7	7	7	7.5	7.5	8	8.5	9	9.5	10.5	11	12	
50	6.5	7	7	7	7.5	7.5	8	8.5	9	10	10.5	11.5	12	
45	6.5	7	7	7	7.5	8	8.5	9	9.5	10	11	12	12.5	
40	6.5	7	7	7	7.5	8	8.5	9	10	10.5	11.5	12.5	13.5	
35	6.5	7	7	7.5	7.5	8	8.5	9.5	10	11	12	13	14	
30	6.5	7	7	7.5	8	8.5	9	10	10.5	11.5	13	14	15	
25	6.5	7	7	7.5	8	8.5	9.5	10.5	11.5	12.5	14	15	16.5	
20	6.5	7	7	7.5	8.5	9	10	11	12.5	13.5	15	16.5	18	
15	6.5	7	7.5	8	8.5	10	11	12.5	13.5	15	16.5	18.5	20	
10	6.5	7	7.5	8.5	9.5	11	12.5	14	15.5	17.5	19	21	22.5	
5	6.5	7	8	9.5	11	13	14.5	16.5	18.5	20.5	22.5	24.5	26.5	
0	6.5	8.5	10.5	12.5	14.5	16.5	18.5	20.5	22.5	24.5	26.5	28.5	30.5	
Ft.		0	2	4	6	8	10	12	14	16	18	20	22	24

(X): Lateral Offset Distance (ft.)

Applications for Non-Overhead Anchorage:

Palmer Safety Class 2 SRD's can also be used in a leading edge/ below D-ring condition. In this condition the Minimum Required Fall Clearance (MRFC) is calculated using five metrics, measured from the walking-working surface:

1. SRD Deceleration Distance
2. D-Ring Shift and Harness Stretch (1 ft.)
3. Safety Factor (2 ft.)
4. Dorsal D-ring Height (5 ft.)
5. Swing Fall

Dorsal D-ring height is added to account for the below D-ring tie-off as compared to the overhead condition. Chart 3 below is calculated using the performance data of the SRD and includes all five metrics listed previously to determine the MRFC.

Diagram 7 - Non-Overhead Anchorage MRFC

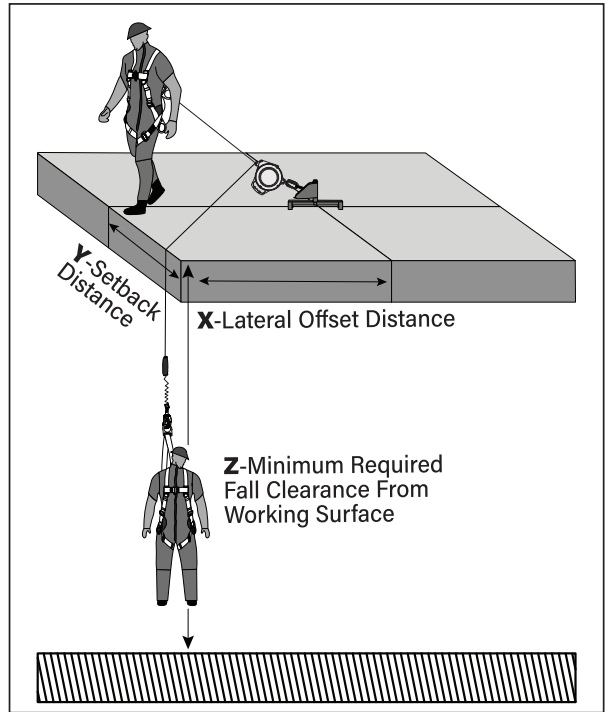

Chart 3 - Calculating Minimum Required Fall Clearance w/Non-Overhead Anchorage

Use this Chart to Calculate Minimum Required Fall Clearance for Non-Overhead Anchorage

The X-Axis represents the Lateral Offset Distance the user is working away from the SRD in 2 foot increments.

The Y-Axis represents the SRD Setback Distance from the Edge in 5 foot increments.

Example: If the SRD is anchored back at least 30 feet, the user needs to work within 16 feet away from the SRD along the edge.

Work Zone Use Areas

- Allowable
- Not Allowed - WORKING IN THIS AREA MAY RESULT IN SERIOUS INJURY OR DEATH

Ft.	(X): Lateral Offset Distance (ft.)												
	0	2	4	6	8	10	12	14	16	18	20	22	24
0	17	19	21	23	25	27	29	31	33	35	37	39	41
5	17	17.5	18.5	20	21.5	23.5	25	27	29	31	33	35	37
10	17	17.5	18	19	20	21.5	23	24.5	26	28	29.5	31.5	33
15	17	17.5	17.5	18.5	19	20	21.5	22.5	24	25.5	27	29	30.5
20	17	17.5	17.5	18	18.5	19.5	20.5	21.5	23	24	25.5	27	28.5
25	17	17.5	17.5	18	18.5	19	20	21	22	23	24	25.5	27
30	17	17.5	17.5	18	18	19	19.5	20.5	21	22	23.5	24.5	25.5
35	17	17.5	17.5	18	18	18.5	19	20	20.5	21.5	22.5	23.5	24.5
40	17	17.5	17.5	17.5	18	18.5	19	19.5	20.5	21	22	23	24
45	17	17.5	17.5	17.5	18	18.5	19	19.5	20	20.5	21.5	22.5	23
50	17	17.5	17.5	17.5	18	18	18.5	19	19.5	20.5	21	22	22.5
55	17	17.5	17.5	17.5	18	18	18.5	19	19.5	20	21	21.5	22.5
60	17	17.5	17.5	N/A	N/A	N/A	N/A	N/A	N/A	N/A	N/A	N/A	N/A

(Z): Minimum Required Fall Clearance w/Non-Overhead Anchorage (Feet)

Angle of Redirection:

The angle of redirection is the angle of the lifeline over an edge during a fall event. The allowable angle of redirection of the lanyard portion of the device at the edge over which a fall might occur (measured between the two sides formed by the redirected lanyard) shall be at least 90 degrees. **DO NOT work with the leading edge above the anchorage.** See Diagram 8 below.

Diagram 8 - Leading Edge Angle of Lifeline Redirection

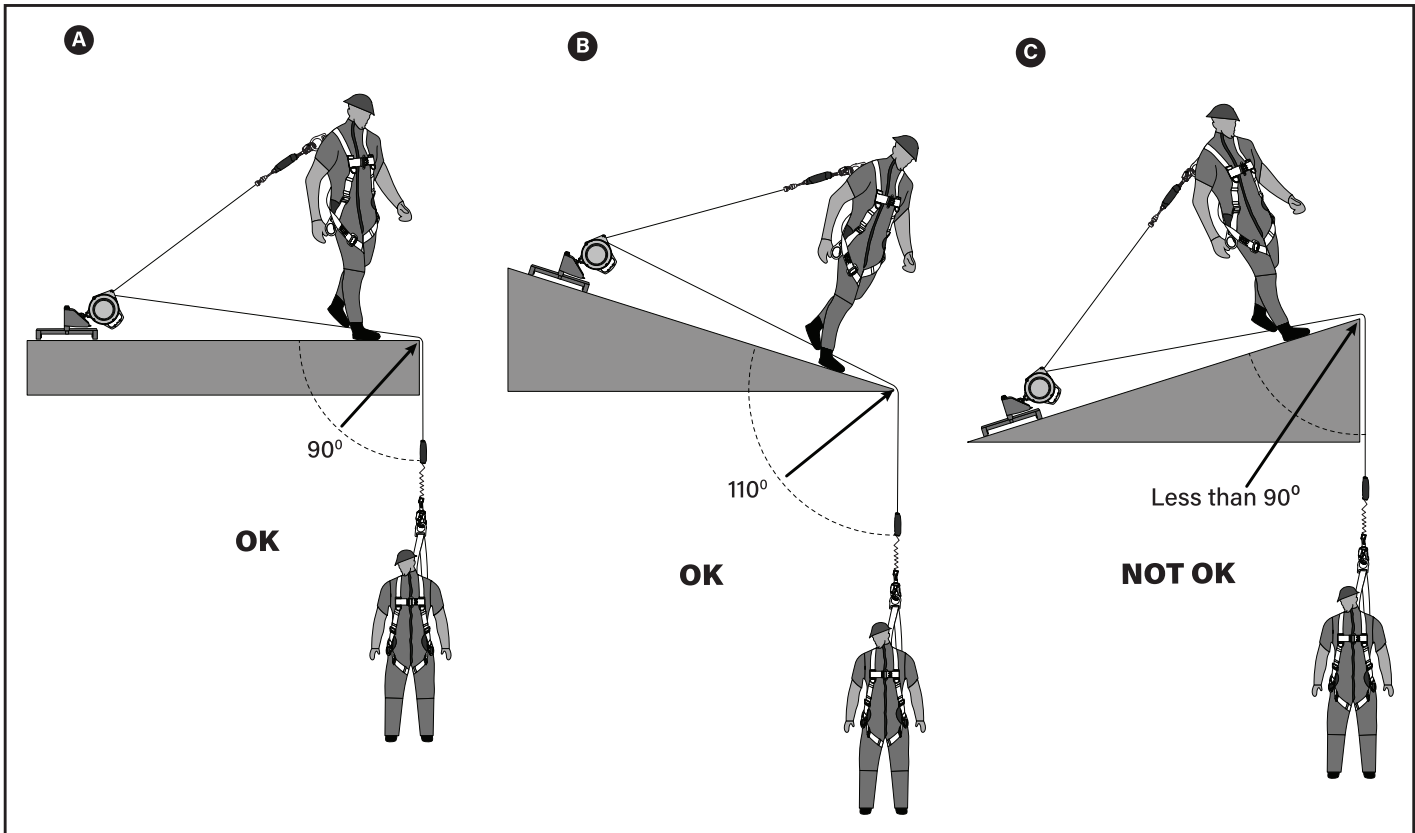

Edge Conditions:

Leading Edge conditions vary, and may be composed of steel, I-beams with purlins, steel deck, metal roofing, or poured concrete or cinder block as shown in Diagram 9.

- A - Structural Steel I-Beams and Purlins**
- B - Steel Deck and Metal Roofing**
- C - Poured Concrete and Block**

Diagram 9 - Extreme Sharp Edges

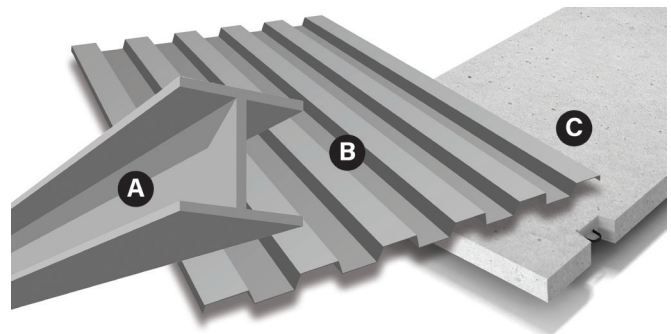

These illustrations aren't meant to represent the complete range of dangerous sharp edges that can be found on work sites so that users can recognize and stay away from them.

Incorrect Use of Class 2 SRD's:

Additional factors to avoid are shown in Diagram 10 below.

DO NOT allow the lifeline to drape over an edge during normal work as this may cause cable damage and compromise the lifeline.

DO NOT attach the anchor on one side of an opening and work on the other side. This can result in creating multiple leading edges and multiple swing fall hazards.

Diagram 10 - Incorrect Use of Class 2 SRD's

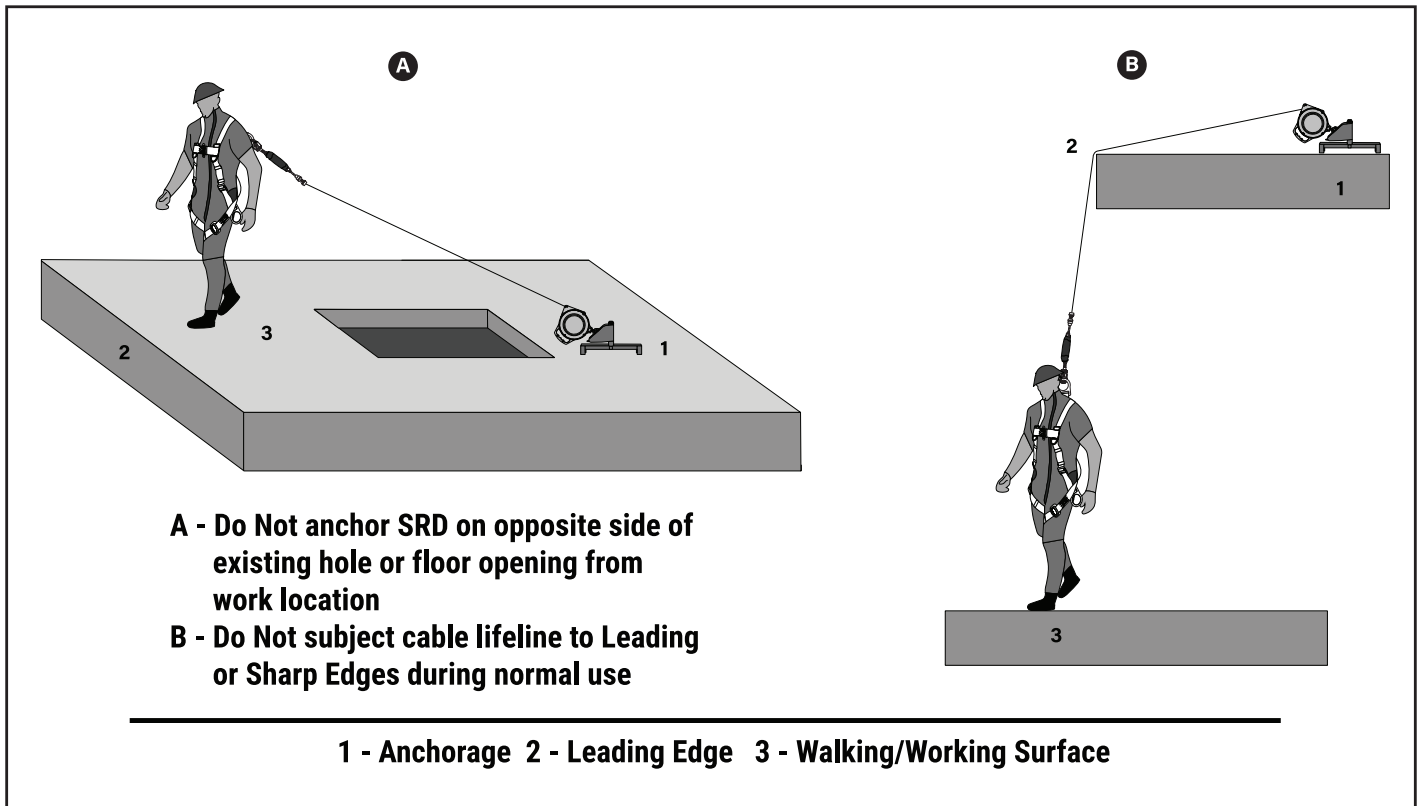

Fall Arrest Impact Indicators:

The load-indicating Energy Absorber is the main impact indication for fall arrest. If fall arrest or equivalent forces have been applied to the Energy Absorber, it will exhibit a deployed status, as seen in Diagram 11. Remove the unit from service if the Energy Absorber exhibits any signs of damage, including a torn or shredded cover, frayed thread, burns, or other trauma. As in Diagram 12, remove the unit from service if the Load Indicating Hook has been deployed.

Diagram 11 - Shock Pack Load Indicator

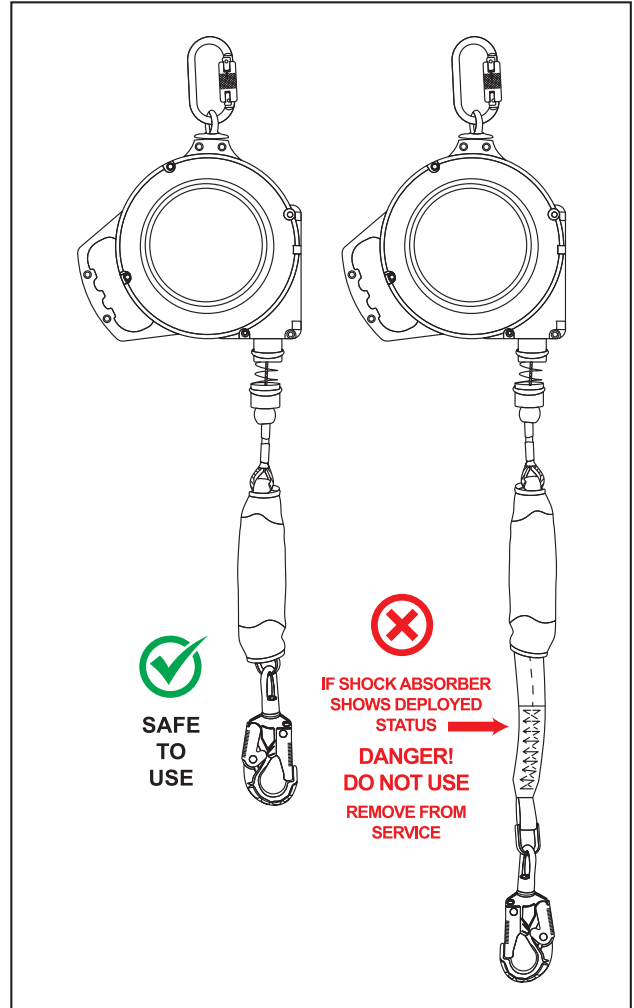
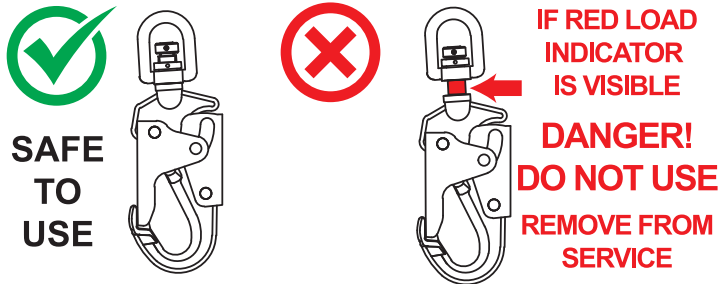

Diagram 12 - Inspecting Load-Indicating Hook



OPERATION, USE AND PLAN:

- **Anchorage:** The anchorage to which the SRL is attached must sustain static loads applied in the directions permitted by the fall arrest system of at least 3,600 lbs. with certification of a qualified person, or 5,000 lbs. without certification. Refer to OSHA and ANSI for specific definition. This device is to only be used by one person. When more than one personal fall arrest system is attached to the same structure, the strength requirements stated above must be multiplied by the number of personal fall arrest systems attached to the structure.
- **Horizontal Systems and Tripods:** In applications where an SRL is used in conjunction with a horizontal system or with a confined space tripod, ensure the support structure and or the horizontal system components are compatible. Horizontal systems must be designed and installed under the supervision of a qualified person.
- **Anchorage Selection:** Select an anchorage point capable of support at least 5,000 lbs. Additionally, select a location for anchorage of the SRL that will avoid a free fall and swing fall hazards. To prevent an increased free fall distance, do not work above the anchorage location.
- **Free Fall:** Avoid slack in the line and do not lengthen the SRL by connecting a lanyard or other snap hooks directly to the retractable.
Do not use this device at or below your feet. This will increase your free fall distance beyond the allowable limits set by OSHA and exceed the capabilities of the SRL to safely arrest a fall
- **Swing Falls:** Swing fall will occur when the anchorage point is not directly over the head of the worker or directly above the point where a fall occurs. The force of striking an object in a swing fall may cause serious injury including death. Minimize swing falls by working as directly below the anchorage point as possible. In all situations where a swing fall can occur, the likelihood of an injury can occur. Please contact Palmer Safety Fall Protection if you have questions on a particular application involving one of our retractable.
- **Fall Clearance:** Ensure that there is always adequate clearance in the path of a fall to avoid striking an object or lower level. A minimum of six feet from the working level to the lower level or nearest obstruction is recommended as long as the SRL is attached directly over head of the worker and the worker is not in danger of insult as a result of a swing fall hazard.
- **Fall Clearance:** Ensure that there is always adequate clearance in the path of a fall to avoid striking an object or lower level. A minimum of six feet from the working level to the lower level or nearest obstruction is recommended as long as the SRL is attached directly over head of the worker and the worker is not in danger of insult as a result of a swing fall hazard.
- **Sharp Edges:** Unprotected and sharp edges can damage the lifeline. Please make sure to avoid working where this can occur and provide protection where possible. A Palmer Safety manufactured energy absorbing device can be added to aid in reducing the impact forces on the entire device. Please contact Palmer Safety Fall Protection for more information.

INSPECTION OF SELF RETRACTING LIFELINES:

- **Before each use of this equipment inspect it according to the following guidelines:** A formal inspection of fall protection products/components must be performed at least every twelve (12) months by a competent person other than the user. The frequency of formal inspections should be based on conditions of use or exposure. Record the inspection results in the inspection and maintenance log at the end of this manual. OSHA 1910.66, OSHA 1926.502 and ANSI Z359.14 requires an inspection of equipment before each use. Before using this equipment, record the serial number information from the label in the inspection and maintenance log at the end of this manual.
- **Annually:** OSHA requires a formal inspection of the SRL be completed by a competent person other than the user at least every 12 months. More formal and frequent inspections may be required based upon the severity and environmental conditions of the workplace. Palmer Safety Retractable, unless otherwise marked, are required to be recertified every two years from the date of first use.

WARNING

If inspection reveals an unsafe or defective condition, remove the product from service and send product back to Palmer Safety authorized service center.

- **After a Fall Arrest:** Inspect the impact indicator on the snap hook of the SRL and look for an exposed red color band. Do not attempt to reset the impact indicator. Remove the retractable from service immediately and return to Palmer Safety or an authorized repair center. If using a retractable with a webbed lifeline, then inspection of the shock pack is required. Remove retractable from service if there are any deformation, elongation or other signs of the shock pack being torn or deployed. If inspection reveals an unsafe condition, remove unit from service immediately and destroy, or contact an authorized service center for repair.

INSPECTING THE SELF RETRACTING LIFELINE:

- Step 1:** Inspect for loose screws and bent or damaged parts.
- Step 2:** Inspect housing for distortion, cracks or other damage. Ensure the swivel eye is not damaged or distorted in anyway. Make sure the swivel eye turns freely.
- Step 3:** The lifeline must fully extend and retract without hesitation or creating a slack line condition.
- Step 4:** Ensure the device locks up when lifeline is jerked sharply.
- Step 5:** The labels must be present and fully legible with inspection log information completed.
- Step 6:** Look for signs of corrosion on the entire unit.
- Step 7:** Wire rope inspection must include identifying cut kinks, broken wires, bird-caging, corrosion, welding splatter, chemical damage, or severely abraded areas. Check all thimbles etc. for excessive wear including cracks or separation of metal components.
- Step 8:** Webbed lifeline inspection must include identifying frayed strands, broken webbing, burns, cuts, and abrasions. Inspect for excessive heat, paint build-up, soiling rust, or chemical damage indicated by brown or discolored areas.
- Step 9:** Inspect indicator hooks, carabiners, and shock packs for signs of deployment, damage, corrosion or excessive wear.
- Step 10:** Record inspection results in the inspection and maintenance log found in this manual. Clearly check off month the SRL was inspected on the label of the housing.



CABLE INSPECTION:

When inspecting SRL's that utilize cable lifelines, it is critical to look for the following damages and deterioration that will result in malfunction of the unit and potentially unsafe conditions.

- **Crushing:** The cable will often get crushed or bent while being used on a job site. Cable that is crushed or bent will damage the retractable and thus the unit should be immediately taken out of service and returned to Palmer Safety or authorized repair center.
- **Cutting:** Movement over sharp edges or other objects while the cable is under tension can result in damaged strands and broken wires. If, through inspection of the retractable lifeline prior to each use, it is found to have any broken strand, immediately remove from service and return to Palmer Safety or an authorized repair center.
- **Abrasion:** Abrasion can result from normal wear. Particular attention must be paid to the outer wire strands as they with each use, it is found have damage or deterioration from abrasion, immediately remove from service and return to Palmer Safety or an authorized repair center.
- **Kinking:** Any deformation in the cable whereas the lifeline appears to be bent, requires the retractable to be immediately removed from service and returned to Palmer Safety or an authorized repair center.
- **Corrosion, Arc or Heat Damage:** Extreme caution must be taken to avoid any potential damage as a result of using a retractable within an environment where corrosive compounds, welding, or high heat may exist. Corrosive damage could cause the cable to crack. Welding damage would result in fused wires and thus change the characteristics of the strength with regards to the wire. If the retractable is used in these environments, the retractable lifeline needs to be closely examined for damage.

Diagram 13 - Inspecting Wire Cable

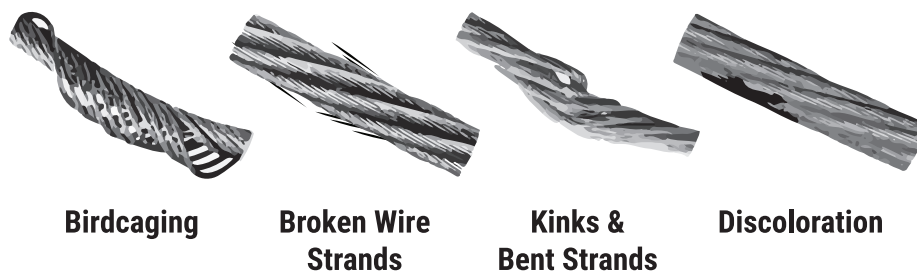

PLAN THE FALL PROTECTION SYSTEM:

Before installation plan your system. Consider all factors that will affect your safety during use of this equipment. The following list gives important points to consider when planning your system:

- **Anchorage:** Select a rigid anchorage capable of supporting the loads no less than 5,000 lbs per worker attached.
- **Sharp Edges:** Avoid working where system components may be in contact with, or abrade against, unprotected sharp edges.
- **After a Fall:** Components which have been subjected to the forces of arresting a fall must be removed from service and destroyed. Retractable must be returned for servicing to Palmer Safety or an authorized repair center.
- **Rescue:** The employer must have a rescue plan when using this equipment. The employer must have the ability to perform rescue quickly and safely.

INSTALLATION REQUIREMENTS:

The following requirements outline the proper installation procedures to be followed.

LOCATION:

- Select a location on an appropriate strength anchorage that will provide overall safety and proper loading. The anchorage must be free of deformities or defects that may weaken the structure. The anchorage to which the SRL is attached must be capable of sustaining static load in the directions applied by the personal fall arrest systems of at least 3,600 lbs. with certification of a qualified person, or 5,000 lbs. without certification.
- When more than one person is attached to the same structure, the strength requirements stated above must be multiplied by the number of personal fall arrest systems.
- Do not work above the anchorage point. While using an SRL, always ensures that there is constant tension on the cable. Slack in the cable could result in an increase in fall distance. Move normally as sudden jerky movements will allow the locking mechanism to engage.
- **Do not install in an area where a swing fall hazard potentially could exist. Failure to do so can result in injury or possibly death.**
- Keep these instructions for reference.

WARNING

If inspection reveals an unsafe or defective condition, remove the Self Retracting Lifeline from service and send back to Palmer Safety or an authorized repair center.

TRAINING:

It is the responsibility of the user and the purchaser of this equipment to assure that they are familiar with these instructions, trained in the correct care and use of, and are aware of the operating characteristics, application limits, and the consequences of improper use of this equipment.

WARNING

Training should be conducted without exposing anyone to a fall hazard. Training should be repeated on a periodic basis in accordance with your organization policy and compliance with OSHA regulations.

MARKING EXPLANATION

The Retractable Fall Arrester is marked with:

- (i) The ANSI mark showing that the product meets the requirements ANSI Z359.14-2021 Class 2
- (ii) Identification of manufactures
- (iii) Type or product code
- (iv) Web/ Wire Rope Length
- (v) Serial Number
- (vi) Month/Year of Manufacture



PALMER SAFETY
 www.palmersafetyus.com

SRL121142

Class **2**
 Anchor above or below dorsal D-ring

6 ft

ANSI Z359.14-2021

PALMER SAFETY
 Part No.: SRL121142
 6 ft. Leading Edge Retractable Web SRL

Mfg. Date _____ Serial # _____

WARNING: Manufacturer's instructions supplied with this product at time of shipment must be read prior to use. Instructions must be followed for proper use, maintenance and inspection. Alterations or misuse of this product or failure to follow instructions may result in serious injury or death.

NOT USER REPAIRABLE.

DO NOT REMOVE THIS LABEL.

USE: Avoid lifeline contact with sharp edges and abrasive surfaces. For use by trained persons only. This device is only for use by one person as a fall arrester. Ensure connection to anchorage is secured properly before use. For clearance requirements, refer to user instructions. Suitable for horizontal use and for use with horizontal lifelines.

INSPECTION: Before each use inspect device per user manual including locking function (pull sharply to test), retraction function, lifeline function, function and condition of connectors housing and fasteners, legibility of labels, and any evidence of defects, damage or missing parts. Inspection by Competent Person required at least every 12 months. Immediately remove from service once defects are found.

SPECIFICATIONS:
 Webbing: 6" LINHPWE, 3/4" width
 Average locking speed: 4.5 ft./sec.
 Average arresting force: 1,350 lbs.
 Max. arresting distance: 42 in.
 Max. arresting force: 1,800 lbs.
 Capacity Range: 130-310 lbs.
 Max. free fall distance: 5'
 Minimum Setback Distance: 0 ft.
 see instruction

ANSI Z359.14-2021 Class 2

Made in Taiwan

SAFE TO USE **DANGER DO NOT USE**
 IF RED LOADING INDICATOR IS VISIBLE

www.palmersafetyus.com

PALMER SAFETY
 www.palmersafetyus.com

SRL121142T

Class **2**
 Anchor above or below dorsal D-ring

6 ft

ANSI Z359.14-2021

PALMER SAFETY
 Part No.: SRL121142T
 6 ft. Leading Edge Twin Retractable Web SRL

Mfg. Date _____ Serial # _____

WARNING: Manufacturer's instructions supplied with this product at time of shipment must be read prior to use. Instructions must be followed for proper use, maintenance and inspection. Alterations or misuse of this product or failure to follow instructions may result in serious injury or death.

NOT USER REPAIRABLE.

DO NOT REMOVE THIS LABEL.

USE: Avoid lifeline contact with sharp edges and abrasive surfaces. For use by trained persons only. This device is only for use by one person as a fall arrester. Ensure connection to anchorage is secured properly before use. For clearance requirements, refer to user instructions. Suitable for horizontal use and for use with horizontal lifelines.

INSPECTION: Before each use inspect device per user manual including locking function (pull sharply to test), retraction function, lifeline function, function and condition of connectors housing and fasteners, legibility of labels, and any evidence of defects, damage or missing parts. Inspection by Competent Person required at least every 12 months. Immediately remove from service once defects are found.

SPECIFICATIONS:
 Webbing: 6" LINHPWE, 3/4" width
 Average locking speed: 4.5 ft./sec.
 Average arresting force: 1,350 lbs.
 Max. arresting distance: 42 in.
 Max. arresting force: 1,800 lbs.
 Capacity Range: 130-310 lbs.
 Max. free fall distance: 5'
 Minimum Setback Distance: 0 ft.
 see instruction

ANSI Z359.14-2021 Class 2

Made in Taiwan

SAFE TO USE **DANGER DO NOT USE**
 IF RED LOADING INDICATOR IS VISIBLE

www.palmersafetyus.com

PALMER SAFETY
 www.palmersafetyus.com

SRL411212

Class **2**
 Anchor above or below dorsal D-ring

12 ft

ANSI Z359.14-2021

PALMER SAFETY
 Part No.: SRL411212
 12ft. Leading Edge Retractable Galvanized Cable

Mfg. Date _____ Serial # _____

WARNING: Manufacturer's instructions supplied with this product at time of shipment must be read prior to use. Instructions must be followed for proper use, maintenance and inspection. Alterations or misuse of this product or failure to follow instructions may result in serious injury or death.

NOT USER REPAIRABLE.

DO NOT REMOVE THIS LABEL.

USE: For use by trained persons only. This device is only for use by one person as a fall arrester. Ensure connection to anchorage is secured properly before use. For clearance requirements, refer to user instructions. Exposure to sharp structural edges could damage the lifeline. This unit is suitable for use with horizontal lifelines. Suitable for horizontal use.

INSPECTION: Before each use inspect device per user manual including locking function (pull sharply to test), retraction function, lifeline function and condition of connectors housing and fasteners, legibility of labels, and any evidence of defects, damage or missing parts. Inspection by Competent Person required at least every 12 months. Immediately remove from service once defects are found.

SPECIFICATIONS:
 Lifeline: 1/2" x 7/32" Galvanized Steel Cable
 Average locking speed: 4.5 ft./sec
 Average arresting force: 1,350 lbs.
 Max. arresting distance: 42 in.
 Max. arresting force: 1,800 lbs.
 Capacity Range: 130-310 lbs.
 Max. free fall distance: 5'
 Minimum Setback Distance: 0 ft.
 see instruction

ANSI Z359.14-2021 Class 2

Made in Taiwan

SAFE TO USE **DANGER DO NOT USE**
 IF RED LOADING INDICATOR IS VISIBLE

www.palmersafetyus.com

PALMER SAFETY
 www.palmersafetyus.com

SRL411222

Class **2**
 Anchor above or below dorsal D-ring

12 ft

ANSI Z359.14-2021

PALMER SAFETY
 Part No.: SRL411222
 12ft. Leading Edge Retractable Galvanized Cable

Mfg. Date _____ Serial # _____

WARNING: Manufacturer's instructions supplied with this product at time of shipment must be read prior to use. Instructions must be followed for proper use, maintenance and inspection. Alterations or misuse of this product or failure to follow instructions may result in serious injury or death.

NOT USER REPAIRABLE.

DO NOT REMOVE THIS LABEL.

USE: For use by trained persons only. This device is only for use by one person as a fall arrester. Ensure connection to anchorage is secured properly before use. For clearance requirements, refer to user instructions. Exposure to sharp structural edges could damage the lifeline. This unit is suitable for use with horizontal lifelines. Suitable for horizontal use.

INSPECTION: Before each use inspect device per user manual including locking function (pull sharply to test), retraction function, lifeline function and condition of connectors housing and fasteners, legibility of labels, and any evidence of defects, damage or missing parts. Inspection by Competent Person required at least every 12 months. Immediately remove from service once defects are found.

SPECIFICATIONS:
 Lifeline: 1/2" x 7/32" Galvanized Steel Cable
 Average locking speed: 4.5 ft./sec
 Average arresting force: 1,350 lbs.
 Max. arresting distance: 42 in.
 Max. arresting force: 1,800 lbs.
 Capacity Range: 130-310 lbs.
 Max. free fall distance: 5'
 Minimum Setback Distance: 0 ft.
 see instruction

ANSI Z359.14-2021 Class 2

Made in Taiwan

SAFE TO USE **DANGER DO NOT USE**
 IF RED LOADING INDICATOR IS VISIBLE

www.palmersafetyus.com

PALMER SAFETY
 www.palmersafetyus.com

SRL911212

Class **2**
 Anchor above or below dorsal D-ring

18 ft

SRL911212

ANSI Z359.14-2021

PALMER SAFETY
 Part No.: SRL911212
 18ft. Leading Edge Retractable Galvanized Cable

Mfg.Date [] Serial # []

WARNING: Manufacturer's instructions supplied with this product at time of shipment must be read prior to use. Instructions must be followed for proper use, maintenance and inspection. Alterations or misuse of this product or failure to follow instructions may result in serious injury or death.

NOT USER REPAIRABLE. DO NOT REMOVE THIS LABEL.

USE: For use by trained persons only. This device is only for use by one person as a fall arrester. Ensure connection to anchorage is secured properly before use. For clearance requirements, refer to user instructions. Exposure to sharp structural edges could damage the lifeline. This unit is suitable for use with horizontal lifelines. Suitable for horizontal use.

INSPECTION: Before each use inspect device per user manual including locking function (pull sharply to test), retraction function, lifeline function, function and condition of connectors housing and fasteners, legibility of labels, and any evidence of defects, damage or missing parts. Inspection by Competent Person required at least every 12 months. Immediately remove from service once defects are found.

SPECIFICATIONS:
 Lifeline: 18 ft. x 7/32" Galvanized Steel Cable
 Average locking speed: 4.5 ft./sec
 Average arresting force: 1,350 lbs.
 Max. arresting distance: 42 in.
 Max. arresting force: 1,800 lbs.
 Capacity Range: 130-310 lbs.
 Max. free fall distance: 5 ft.
 Minimum Setback Distance: 0 ft.
 see instruction

ANSI Z359.14-2021 Class 2
 Made in Taiwan

SAFE TO USE  **DANGER! DO NOT USE IF RED LOAD INDICATOR IS VISIBLE** 

www.palmersafetyus.com

PALMER SAFETY
 www.palmersafetyus.com

SRL711212

Class **2**
 Anchor above or below dorsal D-ring

30 ft

SRL711212

ANSI Z359.14-2021

PALMER SAFETY
 Part No.: SRL711212
 30ft. Leading Edge Retractable Galvanized Cable

Mfg.Date [] Serial # []

WARNING: Manufacturer's instructions supplied with this product at time of shipment must be read prior to use. Instructions must be followed for proper use, maintenance and inspection. Alterations or misuse of this product or failure to follow instructions may result in serious injury or death.

NOT USER REPAIRABLE. DO NOT REMOVE THIS LABEL.

USE: For use by trained persons only. This device is only for use by one person as a fall arrester. Ensure connection to anchorage is secured properly before use. For clearance requirements, refer to user instructions. Exposure to sharp structural edges could damage the lifeline. This unit is suitable for use with horizontal lifelines. Suitable for horizontal use.

INSPECTION: Before each use inspect device per user manual including locking function (pull sharply to test), retraction function, lifeline function, function and condition of connectors housing and fasteners, legibility of labels, and any evidence of defects, damage or missing parts. Inspection by Competent Person required at least every 12 months. Immediately remove from service once defects are found.

SPECIFICATIONS:
 Lifeline: 30 ft. x 7/32" Galvanized Steel Cable
 Average locking speed: 4.5 ft./sec
 Average arresting force: 1,350 lbs.
 Max. arresting distance: 42 in.
 Max. arresting force: 1,800 lbs.
 Capacity Range: 130-310 lbs.
 Max. free fall distance: 5 ft.
 Minimum Setback Distance: 0 ft.
 see instruction

ANSI Z359.14-2021 Class 2
 Made in Taiwan

SAFE TO USE  **DANGER! DO NOT USE IF RED LOAD INDICATOR IS VISIBLE** 

www.palmersafetyus.com

PALMER SAFETY
 www.palmersafetyus.com

SRL111212

Class **2**
 Anchor above or below dorsal D-ring

50 ft

SRL111212

ANSI Z359.14-2021

PALMER SAFETY
 Part No.: SRL111212
 50ft. Leading Edge Retractable Galvanized Cable

Mfg.Date [] Serial # []

WARNING: Manufacturer's instructions supplied with this product at time of shipment must be read prior to use. Instructions must be followed for proper use, maintenance and inspection. Alterations or misuse of this product or failure to follow instructions may result in serious injury or death.



NOT USER REPAIRABLE. DO NOT REMOVE THIS LABEL.

USE: For use by trained persons only. This device is only for use by one person as a fall arrester. Ensure connection to anchorage is secured properly before use. For clearance requirements, refer to user instructions. Exposure to sharp structural edges could damage the lifeline. This unit is suitable for use with horizontal lifelines. Suitable for horizontal use.

INSPECTION: Before each use inspect device per user manual including locking function (pull sharply to test), retraction function, lifeline function, function and condition of connectors housing and fasteners, legibility of labels, and any evidence of defects, damage or missing parts. Inspection by Competent Person required at least every 12 months. Immediately remove from service once defects are found.

SPECIFICATIONS:
 Lifeline: 50 ft. x 7/32" Galvanized Steel Cable
 Average locking speed: 4.5 ft./sec
 Average arresting force: 1,350 lbs.
 Max. arresting distance: 42 in.
 Max. arresting force: 1,800 lbs.
 Capacity Range: 130-310 lbs.
 Max. free fall distance: 5 ft.
 Minimum Setback Distance: 0 ft.
 see instruction

ANSI Z359.14-2021 Class 2
 Made in Taiwan

SAFE TO USE  **DANGER! DO NOT USE IF RED LOAD INDICATOR IS VISIBLE** 

www.palmersafetyus.com

Shock Pack Label

Non-Overhead Anchorage MRFC

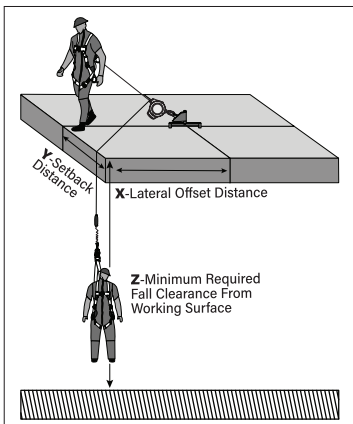

(X): Lateral Offset Distance (ft.) →

Ft.	0	2	4	6	8	10	12	14	16	18	20	22	24
0	17	19	21	23	25	27	29	31	33	35	37	39	41
5	17	17.5	18.5	20	21.5	23.5	25	27	29	31	33	35	37
10	17	17.5	18	19	20	21.5	23	24.5	26	28	29.5	31.5	33
15	17	17.5	17.5	18.5	19	20	21.5	22.5	24	25.5	27	29	30.5
20	17	17.5	17.5	18	18.5	19.5	20.5	21.5	23	24	25.5	27	28.5
25	17	17.5	17.5	18	18.5	19	20	21	22	23	24	25.5	27
30	17	17.5	17.5	18	18	19	19.5	20.5	21	22	23.5	24.5	25.5
35	17	17.5	17.5	18	18	18.5	19	20	20.5	21.5	22.5	23.5	24.5
40	17	17.5	17.5	17.5	18	18.5	19	19.5	20.5	21	22	23	24
45	17	17.5	17.5	17.5	18	18.5	19	19.5	20	20.5	21.5	22.5	23
50	17	17.5	17.5	17.5	18	18	18.5	19	19.5	20.5	21	22	22.5
55	17	17.5	17.5	17.5	18	18	18.5	19	19.5	20	21	21.5	22.5
60	17	17.5	17.5	N/A	N/A	N/A	N/A	N/A	N/A	N/A	N/A	N/A	N/A

(Z): Minimum Required Fall Clearance w/Non-Overhead Anchorage (Feet)

Use this Chart to Calculate Minimum Required Fall Clearance for Non-Overhead Anchorage

The X-Axis represents the Lateral Offset Distance the user is working away from the SRD in 2 foot increments.

The Y-Axis represents the SRD Setback Distance from the Edge in 5 foot increments.

Work Zone Use Areas

Allowable

Not Allowed - WORKING IN THIS AREA MAY RESULT IN SERIOUS INJURY OR DEATH



•Fall Protection •Training •Netting •PPE

Inspection

- 1.) All components of the SRL should be inspected before each use.
If any damage is found or system is involved in a fall remove from jobsite immediately.
- 2.) System should be inspected by a Competent Person at a minimum of every 12 months.
- 3.) All inspections should be documented.

Palmer Safety would be glad to help with any inspections.

***If any damage that could affect the strength or operation of the device, or unsafe conditions are found, proper disposal is required. The anchorage connector must be rendered unusable and then properly discarded.**

Inspection and Maintenance Log

SERIAL NUMBER:			
MODEL NUMBER:			
DATE OF MANUFACTURE:		DATE OF PURCHASED:	

	J	F	M	A	M	J	J	A	S	O	N	D
YR												
YR												
YR												
YR												

Product lifetime is indefinite as long as it passes pre-use and Competent Person inspections. User must inspect prior to EACH use. Competent Person other than user must complete formal at least every 12 months. Competent Person to inspect and initial.

This inspection log must be specific to one SRL. All inspection records must be made visible and available to all users at all times.

If equipment fails inspection or is involved in a fall **REMOVE FROM SERVICE IMMEDIATELY.**

INSPECTION DATE	PART NUMBER	COMMENT	MAINTENANCE PERFORMED
Approved by:			
Approved by:			
Approved by:			
Approved by:			
Approved by:			
Approved by:			
Approved by:			

Product Warranty, Limited Remedy and Limitation of Liability

WARRANTY: THE FOLLOWING IS MADE IN LIEU OF ALL WARRANTIES OR CONDITIONS, EXPRESS OR IMPLIED, INCLUDING THE IMPLIED WARRANTIES OR CONDITIONS OF MERCHANTABILITY OR FITNESS FOR A PARTICULAR PURPOSE. Equipment offered by Palmer Safety is warranted against factory defects in workmanship and materials for a period of one year from date of purchase or first use by the original owner.

LIMITED REMEDY: Upon notice in writing, Palmer Safety will repair or replace all defective items at Palmer Safety’s sole discretion. Palmer Safety reserves the right to require that the defective item be returned to its plant for inspection before determining the appropriate course of action. Warranty does not cover equipment damage resulting from wear, abuse, damage in transit, failure to maintain the product or other damage beyond the control of Palmer Safety. Palmer Safety shall be the sole judge of product condition and warranty options. This warranty applies only to original purchaser and is the only warranty applicable to this product. Please contact Palmer Safety technical service department for assistance.

LIMITATION OF LIABILITY: IN NO EVENT WILL PALMER SAFETY BE LIABLE FOR ANY INDIRECT, INCIDENTAL, SPECIAL OR CONSEQUENTIAL DAMAGES INCLUDING, BUT NOT LIMITED TO LOSS OF PROFITS, IN ANY WAY RELATED TO THE PRODUCTS REGARDLESS OF THE LEGAL THEORY ASSERTED.

Notes:

Notes:



General Work Products LLC
6000 Jefferson Hwy
Harahan, LA 70123
(504) 733-1808
www.PalmerSafetyUS.com